

Data Sheet



Article number: 604142016009

Description: Timing belt pulley with hub
HTD 16 5M 9

Measures

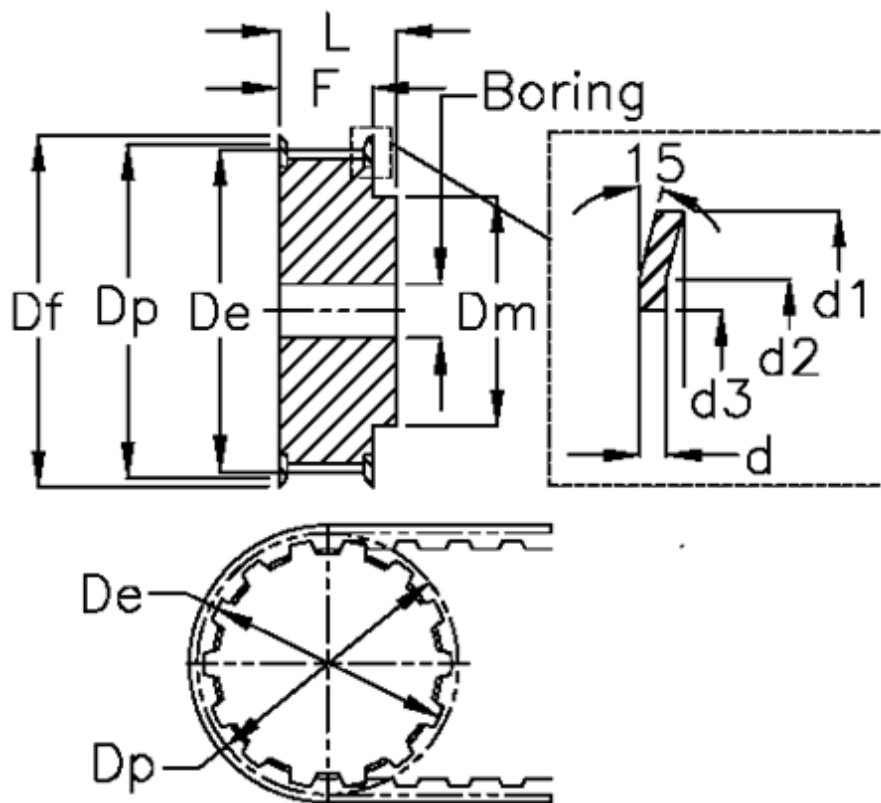

Bore = 6	Dp = 25.46
d = 1	F = 14.5
d1 = 28	Flange type = F09
d2 = 24	L = 20
d3 = 17.8	Tooth number = 16
De = 24.32	Type = 5M
Df = 28	Weight = 0.05
Dm = 16.5	Width = 09